

JUMAT

CYLINDRICAL GRINDING



VERSATILE IN EVERY REGARD



Quality, productivity, availability – the JUMAT external and internal cylindrical grinding machine leaves nothing to be desired. Various sizes and a large number of wheelhead versions offer unrivaled versatility. Paired with the concentrated expertise of JUNKER, each machine is specially matched to the customer's requirements.

EXTERNAL AND INTERNAL GRINDING

The cylindrical grinding machines of the JUMAT series can perform both OD and ID grinding in a single clamping set-up. CBN and diamond grinding wheels enable high-speed grinding, provide for high cutting performance and enable grinding of difficult materials.

EXTERNAL CYLINDRICAL GRINDING

During external cylindrical grinding, the workpieces are clamped between tips or in a collet chuck. To increase productivity, grinding wheel sets are used for some applications. The JUMAT uses the straight and inclined plunge-cut grinding process.

With straight plunge-grinding, the cutting and feed movement is carried out radially to the workpiece. The diameters are ground either in one feed or with several feeds and axial twisting.

With inclined plunge-cut grinding, the grinding wheel is at an angle and the wheelhead (B-axis) is swiveled. The X and Z-axis interpolate. This makes it possible to grind the diameter and flat surfaces in a single feed.

To grind grooves or to pre-grind threads, a galvanically bonded grinding wheel is usually used.

INTERNAL CYLINDRICAL GRINDING

Internal cylindrical grinding enables precise grinding of inside functional surfaces, such as drilled holes, cones or flat surfaces. High-speed grinding spindles are used to achieve the desired cutting speed, despite the smaller grinding wheel diameter.

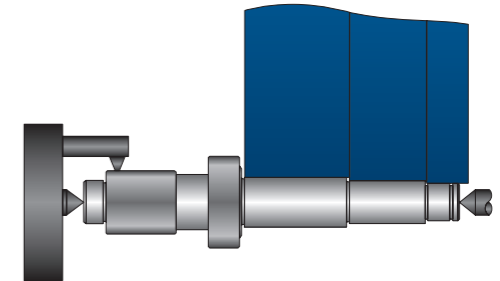

Straight plunge-grinding (with wheel set)

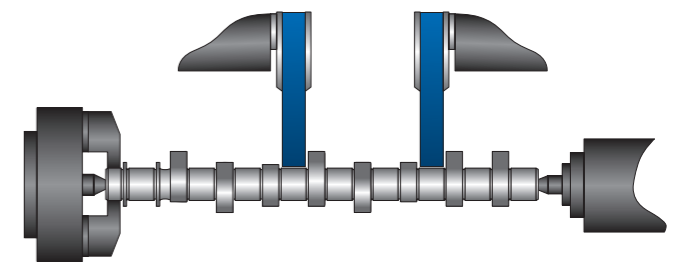

Straight plunge-grinding (with single wheels)

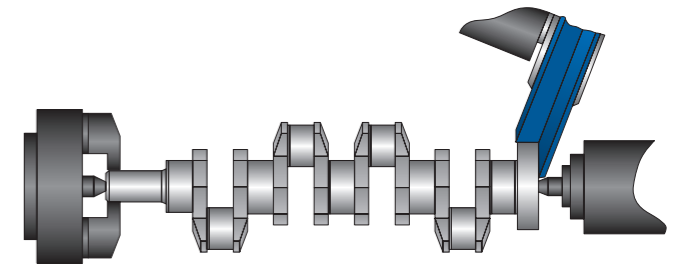

Angled infeed grinding

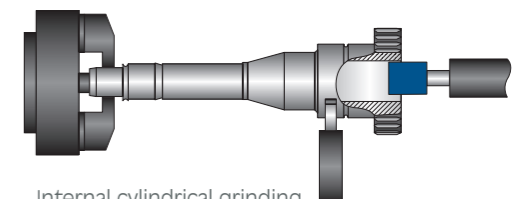

Internal cylindrical grinding

THE ECONOMICAL MULTI-TALENT FOR ANY USE

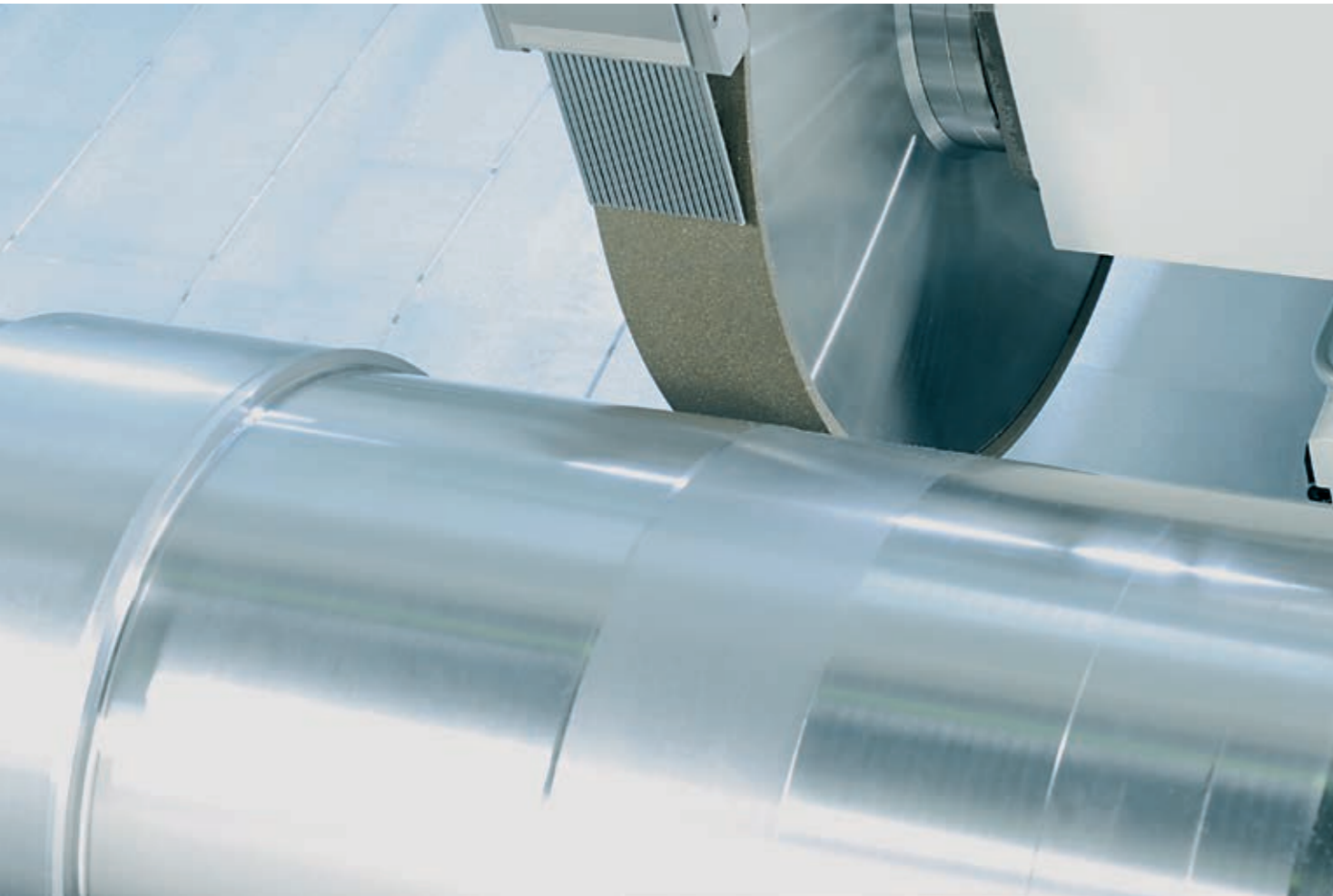

HIGHLIGHTS

- **High dimensional accuracy** thanks to various measuring systems
- **Long tool life** through use of CBN or diamond grinding wheels
- **Versatility** due to a large number of wheelhead versions
- **Minimized undulations** due to grinding wheel balancing on two levels
- **Fast changeover** through patented 3-point mounting interface

WORKPIECE SPECTRUM

The cylindrical grinding machines of the JUMAT series grind the diameter, flat shoulders, grooves, cones and chamfers in individual or combined operations.

The versatility of the JUMAT has proven itself in a broad range of industries. Typical workpieces include:

- **Shafts**, such as gearshafts, rotor or camshafts
- **Injection pump parts**, such as pump pinions or exhaust valves
- **Threaded parts**, such as steering racks or ball screw nuts

CENTER DRIVE

The center drive is a special drive system which clamps the workpiece in the center and drives it via a servomotor. This enables both workpiece ends to be ground at the same time.



GRINDING OF STEERING RODS

In the automotive industry, electromechanical, axially parallel power steering systems are increasingly used. The JUMAT grinds the outside thread of the steering rod in as single clamping set-up from a solid blank. Pre-grinding is carried out with galvanically bonded grinding wheels, and finish grinding with vitrified bonded CBN grinding wheels.

GRINDING OF BALL SCREW NUTS

The double workpiece headstock, with two opposing clamping devices, minimizes the downtime when grinding threads of ball screw nuts: While grinding is being carried out on one side, loading and unloading, positioning and clamping are carried out on the other. The only downtime: Swiveling by 180 degrees in less than 3 seconds.



EQUIPMENT AND OPTIONS

IN-PROCESS MEASURING SYSTEM

A digital measuring head measures the bearing diameter and the concentricity in the process. The control system logs the measured values, calculates the correction data and compensates process influences due to temperature fluctuations or grinding wheel wear.

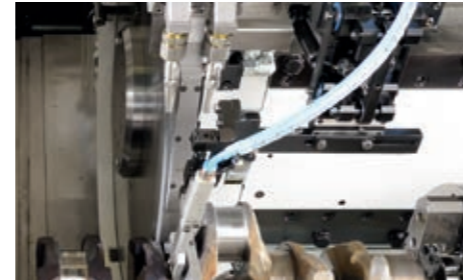

WHEELHEAD VERSIONS

The broad range of wheelhead versions provides for great flexibility. Up to three grinding spindles are mounted on each wheelhead. As a result, even complex workpieces requiring several grinding tasks can be ground in one machine and in a single clamping set-up.



STEADIES

As an option, self-centering three-point steadies ensure stable support. Tracking hydraulic jaws guarantee a balanced ratio of forces at all three support points, and with it a grinding process with repeat accuracy.



LONGITUDINAL POSITIONING

A touch probe measures the longitudinal position of the workpiece on a flat surface to compensate for unmachined part fluctuations. The measured values are automatically integrated in the grinding process by the control system.

TAILSTOCK AND WORKHEAD WITH CNC

The position of both the tailstock and the workhead can be adjusted with CNC. This option is used both for combined external and internal grinding and for the automatic conversion of workpieces of various lengths or in individual part production.



CONTROL SYSTEM

The Erwin Junker Operator Panel was specifically developed to control grinding machines. All machine components are controlled using the operator panel – irrespective of the series and the used control system. The identical structure, intuitive menu guidance and visualization of the workpiece geometry make for extreme user convenience and flexibility in operation. Programming takes place directly using the operator panel or an external programming tool.



AXIS DRIVE AND GUIDANCE

With platforms 1 to 8, the wheelheads traverse along the Z axis. The mechanical direct drive uses the rack and pinion to perform play-free positioning depending on both load and temperature – thanks to two drive motors per slide. With platforms 1000 to 5000, the grinding table traverses on a flat prism guide with pre-tensioned ball screw.

The X axis with hydrostatic round guide carries out stick-slip-free positioning with minimal wear and maintenance requirement – due to the absence of any metal contact between the guide column and housing. Drive takes place by means of an ultra-precise hydrostatic feed spindle which is suitable for extremely high forces and has no acceleration limit.

The B axis of the wheelheads is driven by a play-free gear or torque motor. Every angular position is programmable; the path measuring system has a sensational resolution of 0.00001 degrees. The directly driven grinding spindles – internally produced – ensure extremely low-noise running, with structure-borne sound sensor and dynamic balancing system on one or two levels.

CLAMPING FIXTURE

The patented 3-point mounting interface allows grinding and dressing wheels as well as work holdings to be mounted and centered on grinding spindles, workpiece spindles and tailstock sleeves in record time. Adjustment of the tailstock and, where applicable, the workhead take place using optionally using a chain wheel, a hydraulic cylinder or a CNC axis with rack and pinion drive. An airlift function simplifies position adjustment. Depending on the workpiece, in addition a wide range of clamping systems are also available.

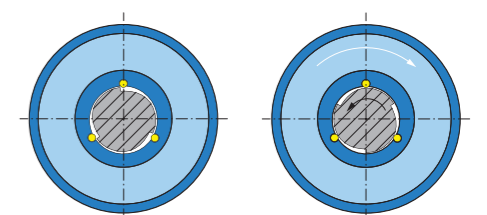

MACHINE BED

The machine bed made of cast mineral provides impressive damping behavior and torsional rigidity. The temperature stability allows fluctuations in the ambient temperature to be compensated with a minimum of effort, ensuring a high level of dimensional stability throughout the whole day.



LOADING SYSTEMS

JUNKER offers both internal and external loading systems for all its machine series, depending on customer and workpiece requirements. The loading systems can be combined with different infeed and discharge systems such as conveyor belts or custom tailored systems.

MEASUREMENT SYSTEMS

The measurement systems are also individually adjusted to the various workpieces and customer specifications. The measurement processes entail evaluating the recorded measured values and utilizing them for measurement correction in line with the prepared measurement strategy. A grinding wheel measuring system to determine the diameter, axial position and width of the grinding wheel completes the wide range of systems on offer.



DRESSING UNIT

Grinding wheel dressing is CNC controlled. A driven diamond dressing wheel or a workpiece-dependent diamond profile roller can be used. Dressing takes place manually or using an automatic dressing program with grinding wheel compensation.

ABRASIVE

Depending on the application, the abrasive CBN or diamond is used. The basic bodies of the grinding wheels comprise steel or carbon. In conjunction with CBN, it can make sense to use a carbon base body: It is light, has vibration-damping properties and remains dimensionally stable even at high speeds.

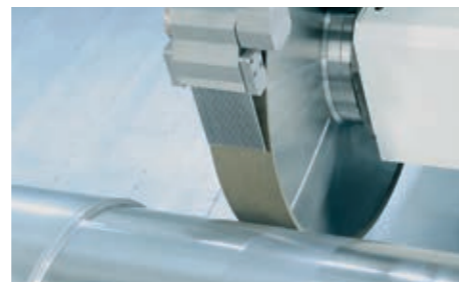

FIRE PROTECTION AND LTA AIR FILTER

In case of a fire, the machine interior is automatically hermetically sealed, suffocating a fire before it has a chance to spread. If required, extinguishers (CO₂ or water mist systems) and exhaust air purification systems can be additionally installed. A competent partner for fire protection and filtration solution solutions is LTA Lufttechnik GmbH, which also belongs to the JUNKER Group and which researches, develops and produces filtration systems for industrial air purification.

FIELDS OF COMPETENCE

TECHNOLOGY CENTERS

The JUNKER Technology Centers in Nordrach, Germany and in Holice, Czech Republic offer a wide selection of grinding machines for demonstrations and customer-specific grinding tests. These facilities give potential buyers and customers the chance to be impressed by the technical and economic performance of JUNKER and ZEMA grinding machines and test them on their own workpieces.

SERVICE

The company group's growing sales and servicing network ensures satisfied customers worldwide. JUNKER Premium Service acts swiftly and with outstanding expertise wherever its customers are around the globe. Available around the clock, this service provides the assurance of planning security for customers: The highly qualified team will find the right solution no matter what the problem.

ENERGY EFFICIENCY

The key indicator for the efficiency of a machine tool is the energy requirement for each good part produced. Through the use of JUNKER grinding machines, this value is continuously dropping. As the number of grinding steps possible in a single machine increases, machine downtimes diminish and precision improves. The company's energy management program continues to uncover and leverage added potential for savings. Examples include frequency-regulated components, recovered braking energy or optimized sealing air consumption in our own internally developed grinding spindles.

PRODUCTION LINES

JUNKER is able to provide comprehensive references for the design and implementation of production lines ideally tailored to the specific requirements of its customers. As a general contractor, JUNKER places added importance on standardized interfaces such as workpiece transport, coolant systems or measuring devices. This enhances efficiency and ensures the long-term interaction of all the different components of a production line.

NON-STANDARD SOLUTIONS

A new grinding technology challenge for JUNKER? „Tell us what your grinding challenge is and we'll supply you with the perfect machine.“ The engineers and technicians of the JUNKER team are able to draw on an enormous fund of technological expertise to provide customized solutions for every field of application. Top priority: Increasing workpiece quality, reducing cycle times.

TECHNICAL DATA



PLATFORM	1S	1000	3000	5000	6XS	6S	6L	6XL
Available wheelhead versions	/10 /10i /15 /18 /20 /50	/10 /10i /15 /17 /20 /50	/10 /10i /15 /20 /30 /40 /50 /60	/10 /10i /15 /20 /30 /40 /50 /60	/10 /10i /15 /20 /30 /40 /50 /60	/10 /10i /15 /20 /30 /40 /50 /60	/10 /10i /15 /20 /30 /40 /50 /60	/10 /10i /15 /20 /30 /40 /50 /60
Number of wheelheads	1	1	1	1	1	1 2	1 2	1 2
Grinding length	150 mm	150 mm	400 mm	700 mm	500 mm	1.000 mm 750 mm	1.800 mm 1.500 mm	2.800 mm 2.500 mm
Clamping length	150 mm	150 mm	400 mm	700 mm	600 mm	1.200 mm	2.000 mm	3.000 mm
Center height	100 mm	100 mm	150 mm	170 mm	170 mm	170 mm	170 mm	170 mm
Workpiece weight	5 kg	5 kg	15 kg	130 kg	130 kg	150 kg	200 kg	300 kg
Grinding wheel diameter (max.)	350 mm	350 mm	350 mm	500 mm	500/700 mm	500/700 mm	500/700 mm	500/700 mm
Peripheral diameter	80 mm	80 mm	150 mm	280 mm	280/320 mm	280/320 mm	280/320 mm	280/320 mm
W x D x H mm (without peripherals)	1.800 x 2.500 x 2.100	1.500 x 2.500 x 2.100	3.400 x 2.800 x 2.200	4.900 x 3.400 x 2.350	3.260 x 3.750 x 2.450	4.100 x 3.750 x 2.450	4.900 x 3.750 x 2.450	6.400 x 3.750 x 2.450
Weight	10.000 kg	9.000 kg	12.000 kg	17.000 kg	20.000 kg	25.000 kg 28.000 kg	28.000 kg 31.000 kg	31.000 kg 34.000 kg

WHEELHEAD VERSIONS

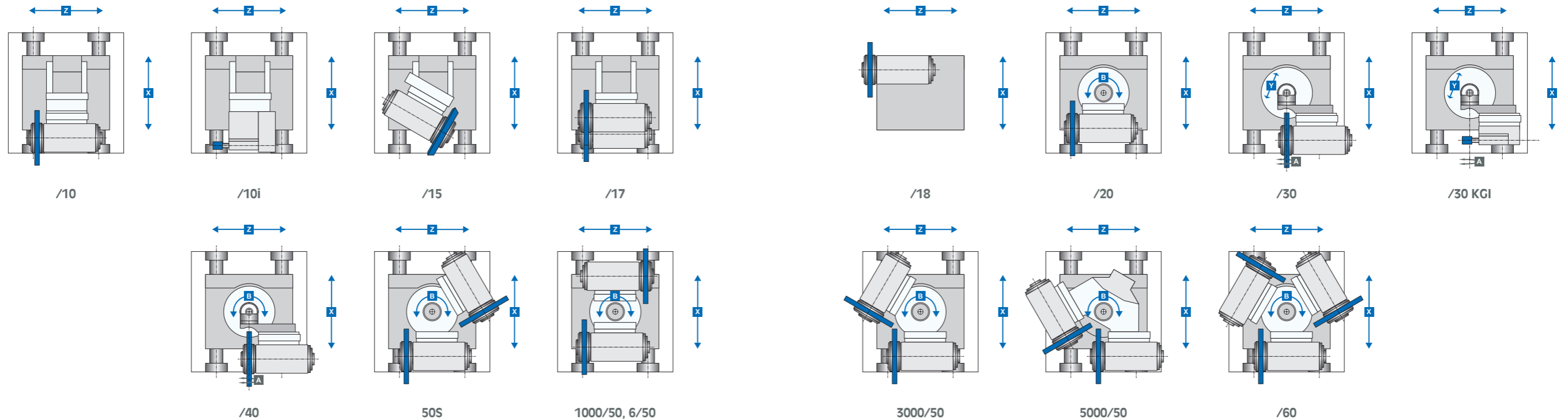

EUROPE

Erwin Junker Maschinenfabrik GmbH

Junkerstraße 2
77787 Nordrach
Germany

info@junker.de
+49 7838 84-0

Erwin Junker Grinding Technology a.s. Plant Holice

Pardubická 332
534 01 Holice
Czech Republic

info@junker.cz
+420 466 003-111

Erwin Junker Grinding Technology a.s. Russia Branch Office

Prospekt Tolbukhina 17/65
150000 Yaroslavl
Russian Federation

info@junker-russia.ru
+7 4852 206121

**JUNKER
GROUP**

Erwin Junker Makina Sanayi Ticaret LTD. ŞTİ.

Esentepe Mah.
Milangaz Cad. No:75
Monumento
Kartal/Istanbul
Turkey

info@junker-turkey.com.tr
+90 216 5042811

LTA Lufttechnik GmbH

Junkerstraße 2
77787 Nordrach
Germany

info@lta-filter.com
+49 7838 84-245
www.lta-filter.com

LTA Industrial Air Cleaning Systems s.r.o.

Lidická 66
252 68 Středokluky
Czech Republic

info@lta-filter.com
+420 233 012-113
www.lta-filter.com

AMERICA

Erwin Junker Machinery, Inc.

2541 Technology Drive, #410
Elgin, IL 60124
USA

info@junker-usa.com
+1 847 4880406

Erwin Junker de Mexico, S. de R.L. de C.V.

Blvd. Bernardo Quintana #7001
Torre 2, #1203
Centro Sur Querétaro
Qro., C.P. 76079
Mexico

info@junker.com.mx
+52 442 1995111

Erwin Junker Máquinas Ltda.

Estrada do Capivari 751
Cep 09838-900
S.B. do Campo, São Paulo
Brazil

info@junker-group.com.br
+55 11 4153-9645
+55 11 4397-6008

LTA Industrial Air Cleaning Systems, Inc.

2541 Technology Drive, #410
Elgin, IL 60124
USA

info@lta-filter.com
+1 847 4880406
www.lta-filter.com

ZEMA Zselics Ltda.

Estrada do Capivari 741
Cep 09838-900
S.B. do Campo, São Paulo
Brazil

zema@zema.com.br
+55 11 4397-6000
www.zema.com.br

ASIA

Erwin Junker Maschinenfabrik GmbH Shanghai Representative Office

Unit 1003, Floor 10
Tower II Kerry Ever Bright City
Enterprise Center
No. 209 Gonghe Road
200070 Shanghai
P.R. China

info@junker.com.cn
+86 21 61438528

Erwin Junker Machinery (Shanghai) Co., Ltd.

Section D, Floor 6, Building 16#
No.69 Xi Ya Road
Waigaoqiao Free Trade Zone
200131 Shanghai
P.R. China

services@junker.com.cn
+86 2150 463525

Erwin Junker Maschinenfabrik GmbH India Branch Office

Office No. 805, Deron Heights
Baner Road,
Pune 411 045
India

info@junker.in
+91 20 27293403